

ECOUSTIC® TORQUE



unika vaev

INSTYLE

Hear yourself think®

ECOUSTIC® COLORS



AQUA



AUBERGINE



BALTIC



BERRY



CAMEO



CAPER



CHARCOAL



COBALT



CREAM



DOVE



FIELD



FOSSIL



FRESCO



GREEN



INDIGO

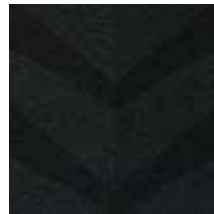

JET



LEMON



LIGHT GREY



LIME



NATURAL



NAUTICAL



OATMEAL



OPAL



ORANGE



OYSTER



PAPRIKA



PEWTER



QUARTZ



RED



SKY



SPRAY

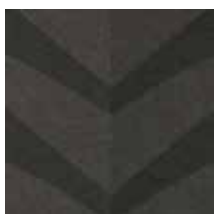

TAUPE



WHITE



YELLOW

Patterns shown are not to scale
Product may vary in color due to the nature of the media
Please refer to website for current color range

ecoustic® global leaders
by INSTYLE in acoustic
products

ECOUSTIC® TORQUE

Front View

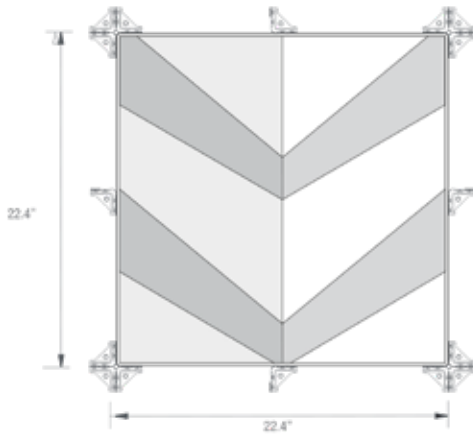

Side View



CONTENT 100% PET (up to 23% recycled content)

DIMENSIONS 22 7/16" (w) x 22 7/16" (h) x 1 5/8" (d)
(570mm x 570mm x 42mm)

ORIGIN Australia

APPLICATION Horizontal, Vertical Surfaces, Wall

LIGHTFASTNESS
ISO 105-B02 > 6

FIRE RATINGS
ASTM E84 Class A / Class B with ecoustic® infill
AS/NZS 3837
ISO 5660.1
GB 8624

ACOUSTIC NRC 0.60 / 0.80 (With ecoustic® infill)

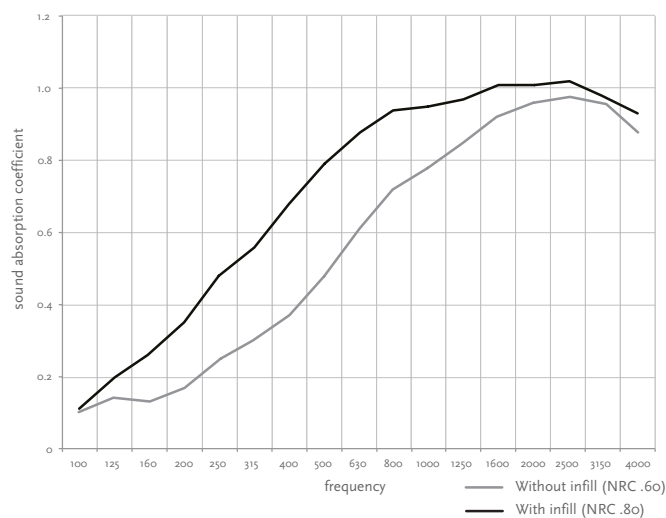

BENEFITS

Designed for the Environment: ecoustic® Torque tile is made from over 50% recycled Pet. easy to disassemble and separate into the appropriate recycling systems, ecoustic® Torque tile can be recycled.

- Mindful MATERIALS
- Cal 01350 Compliant
- Low-VOC
- Declare CDHP Emissions Compliant
- HHI Compliant
- Global Greentag
- Contributes to LEED
- HPD

Low VOC + Greentag Certification: ecoustic® Torque tile is certified Low-VOC and third party certified with Greentag Level A Certification.

LEED: the ecoustic® Torque tile is composed of 50% post consumer content, which contributes to LEED MR Credit 4 Recycled Content.

Lightweight, Easy to Handle + Install: ecoustic® Torque is a modular tile that is easy to install and reinstall. Screw the sound chamber directly to your wall and then velcro the tile. The design can be easily extended at a later stage.



ECOUSTIC® TORQUE COMPONENTS

Screws (not included) Flat head c/sunk 1" [2 per 4-way clip]

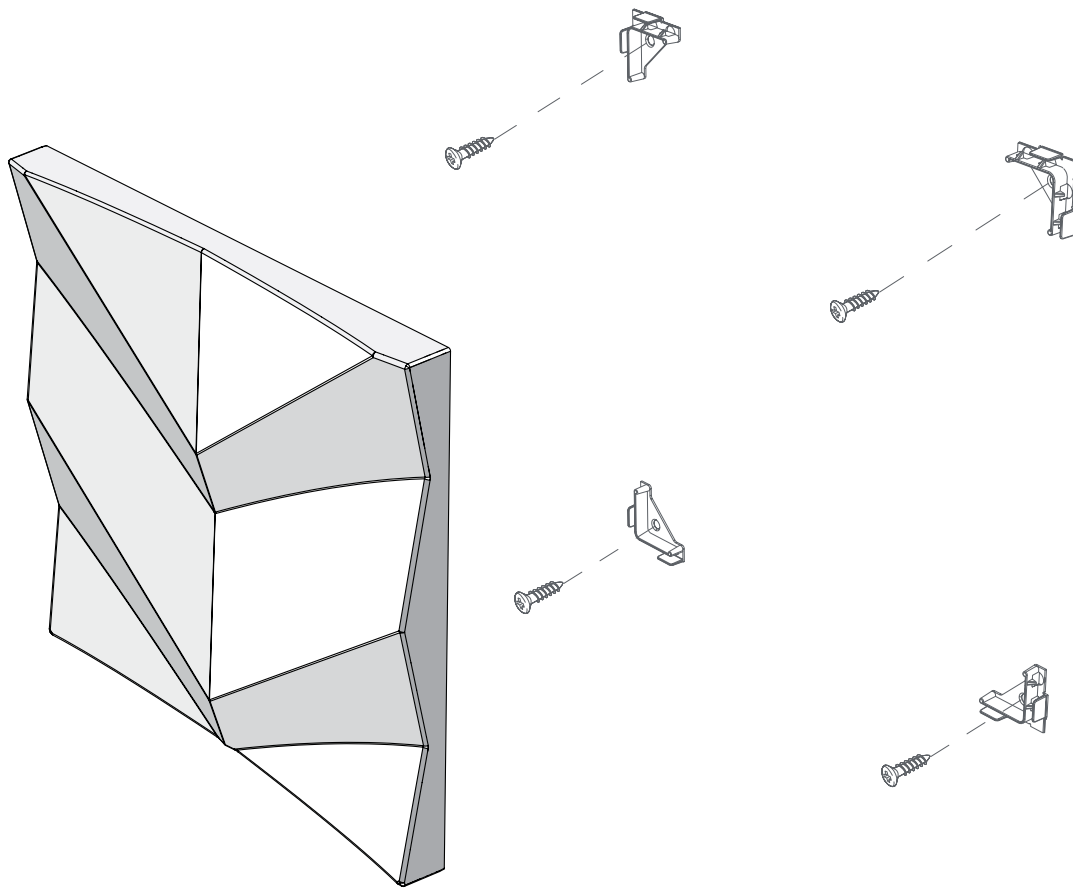

Clip layout example - 62.2" x 62.2"

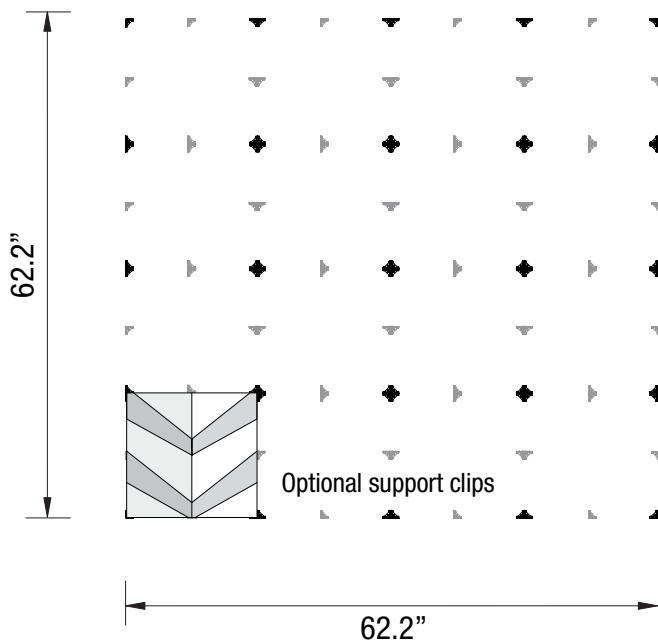

4 way clip - Clear ABS

8 + 1 spare 4 way clips are supplied in each box
Single clip template is also included in each box

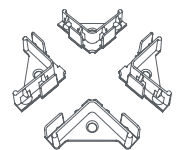
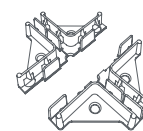
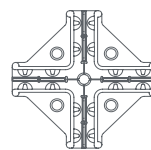

Complete

Use a complete clip for each junction of 4 tiles

Half

Break clip in half for each straight edge 2 tile joins

Quarter

Break clip into quarters for each single tile corner