

# ECOUSTIC SCULPT™ ADD + SUBTRACT



*unika vaev*  
—  
INSTYLE

Hear yourself think®

# ECOUSTIC SCULPT™ COLOR



ALMOND



ARIZONA



BLUEBELL

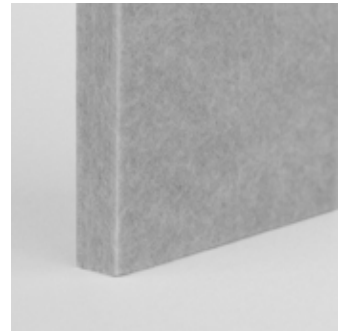

COOL



DENIM



FAWN



GALAXY



HORIZON



IRIS



LEAF



OLIVE

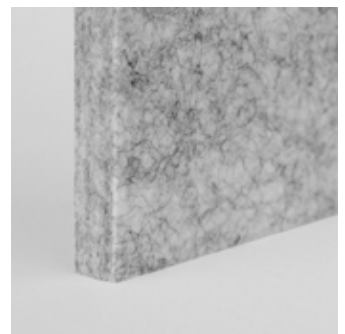

OXIDE



SNOWDROP



TUNGSTEN



VENUS

Product may vary in color due to the nature of the media  
Please refer to website for current color range

**ecoustic**® global leaders  
by INSTYLE in acoustic  
products

# ECOUSTIC SCULPT™ ADDSUBTRACT

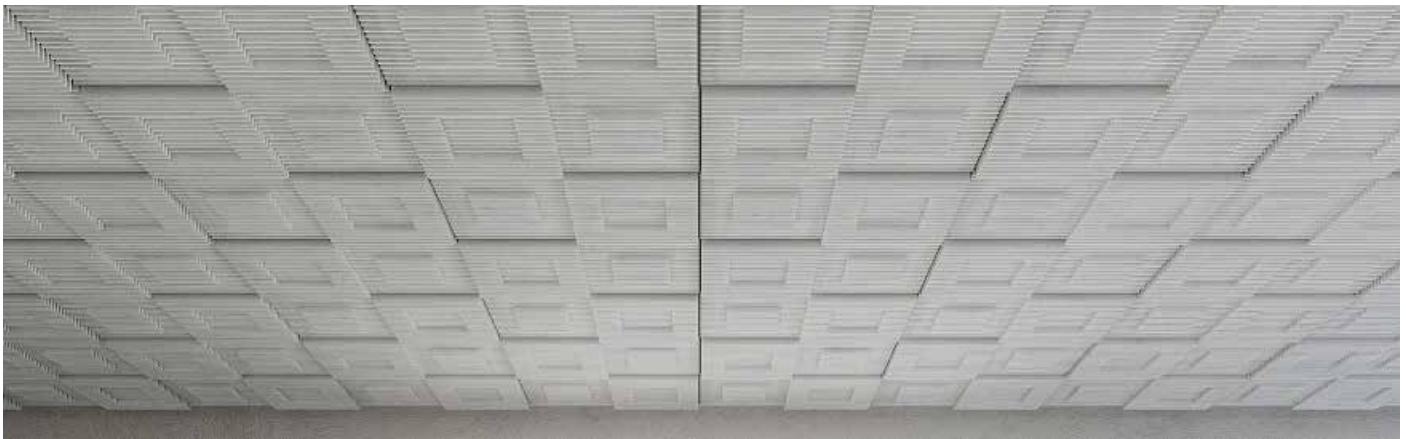

**CONTENT** 100% PET Panels with aluminum rails

**DIMENSIONS** 48 Tile- 47 13/16" x 23 13/16" x 4 1/2"  
(1215mm x 605mm x 115mm)  
Drops into existing T-Frame  
suspended ceiling systems with a  
nominal 48" x 24" grid.

**APPLICATION** Ceiling

**FIRE RATINGS**  
ASTM E84 Class A  
AS/ISO 9705  
AS/NZS 1530.3  
CAN ULCS102

**VOC**  
Cal 01350 Complies

**ACOUSTIC** Base NRC: 0.65 - 0.75 (Applies to all profiles)  
With Infill NRC: 0.90 (Applies to all profiles)  
\*See graph on following page

**DROP CEILING** ecoustic Sculpt™ Ceiling tile is designed to be compatible with 9/16" (15mm) and 15/16" (24mm) exposed tee grid systems in slim and standard profiles.  
**Grid type must be specified with order.**

**DESCRIPTION** The Sculpt™ 'Add + Subtract' design evolved from creating a positive form from a negative extraction. The individual profiles are similar to an architectural battlement that are found in the shielding walls and towers of medieval castles. The profile utilizes equally spaced intervals so when installed as a collection of four tiles they create a square formation moving in and out. The tiles are ideally suited for a large ceiling installment to capture the form of the design.

**Designed for the Environment:**

- Mindful MATERIALS
- Cal 01350 Compliant
- Low-VOC Certified
- Oeko-Tex Certified
- Prop 65 Compliant
- Declare CDHP Emissions Compliant
- HHI Compliant
- Global Greentag
- HPD
- ISO 14001-certified Environmental Management System
- Solid Core panels used to produce ecoustic® Baffle are Cradle to Cradle - Bronze certified

**Building Rating Systems:** Sculpt will contribute the following points for Green Star, LEED + WELL building standards.

| Criteria                 | Green Star | LEED | WELL |
|--------------------------|------------|------|------|
| Low VOC                  | √          | √    | √    |
| 3rd Party Certification  | -          | √    | √    |
| Toxic Material Reduction | N/A        | N/A  | √    |
| Sound Reducing Surfaces  | N/A        | N/A  | √    |

**Award-Winning + Patented Design:** The unique ecoustic Sculpt™ ceiling tile system has been awarded Australian Innovation Patent, New Zealand, United States & Patent Co-operation Treaty Patent Pending. ecoustic Sculpt™ has won four international awards:

- Neocon Best New Acoustic Panels and Solutions Gold Award 2018
- Good Design Australia Gold Award 2019
- Architizer A+Awards Finishes – Ceilings Winner 2019
- Interior Design Excellence Award Object Winner 2019



# ECOUSTIC SCULPT™ ADDSUBTRACT

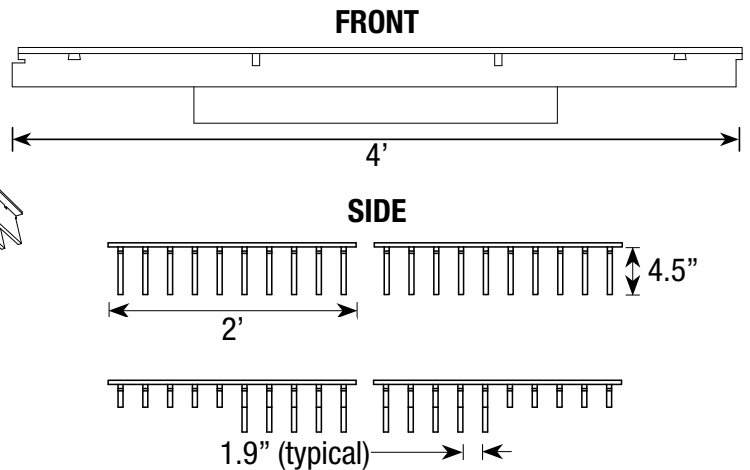
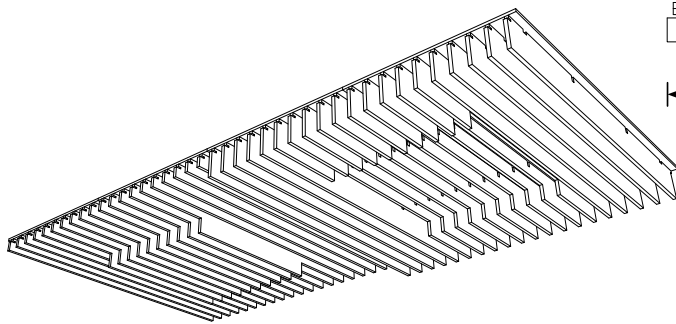

The above drawing shows (2) Add and (2) Subtract tiles

## ACOUSTIC RESULTS

ecoustic Sculpt™ consists of 15 profiles each with different surface areas. Acoustic testing was performed on the smallest (Network) and largest (Icon) profiles, with and without ecoustic® Infill. This gives ecoustic Sculpt™ a NRC range that covers all 15 profiles.

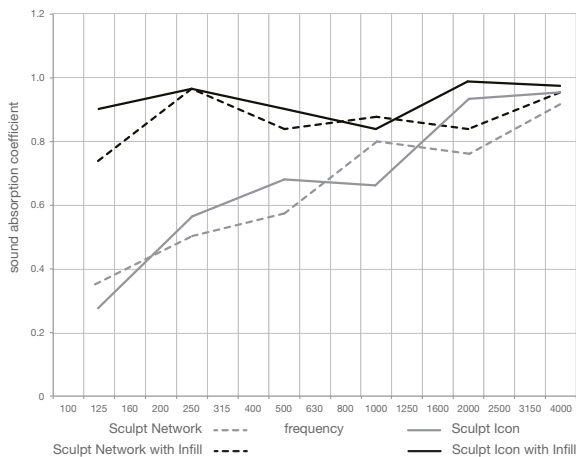

**Versatile Ceiling Design Feature:** ecoustic Sculpt™ tiles can be assembled in varying orientations to create a large-scale ceiling design feature. The tiles can be installed in an identical linear formation, mirrored to create larger shapes across multiple tiles or in a random orientation. Additionally, alternate 2' x 2' tiles can be rotated 90° to create a checkerboard pattern. Multiple colors can be featured to create added depth and interest.

**Customizable:** Architects and interior designers can also create their own custom designs for an interior scheme with the ecoustic Sculpt™ system. Please refer to our ecoustic Sculpt™ Custom Design Guide.

**Assembly Options:** An installation of 4 or more Add + Subtract tiles creates square formations that begin to move in and out. Ideally suited to larger spaces to showcase the design's scale and form.

Installation pattern options may influence tile profile assembly. Written specification / Reflected Ceiling Plan reference to installation pattern is recommended.

## IMPORTANT

**Profile Options:** The 'AddSubtract' tile is available in the original design, 'AddSubtract' and also as simply the 'Add' tile, or the 'Subtract' tile. See the following page for more details.

**Toxicity:** Polyester is nontoxic and is classed the same as wood under the state of New York article 15 Part 1120. ecoustic Sculpt™ Ceiling tile does not contain any Red list chemicals (USA EPA), free of PFCs, flame retardants, phthalates, and urea formaldehyde.

**Environment:** Certified low-VOC and Oeko Tex, the raw material ecoustic® SC is non-toxic, non-irritant and non-allergenic. The raw materials of Sculpt are third party certified by Oeko Tex.

**Green Star + LEED:** ecoustic Sculpt™ can achieve Green Star low-VOC points

**Recyclable:** ecoustic Sculpt™ Tiles are recyclable.

**Moisture Absorption:** Exposure to an atmosphere of 50% and 95% RH for four days provides moisture absorption of less than 0.2% per volume. As ecoustic Sculpt™ is 100% polyester, it will not degrade over time due to moisture, mildew, or rot in office environments.

**Fixtures:** Any fixtures must be supported independent to the ecoustic Sculpt™ Ceiling tile. ecoustic Sculpt™ Ceiling tile can be cut on site to accommodate for new and existing lighting and fixtures.

**HVAC:** Ensure ecoustic Sculpt™ Ceiling tile is compliant with the specified HVAC system. ecoustic Sculpt™ Ceiling tile is recommended for Ducted Return Air and is not Plenum Return Air rated.

**Back Loading:** ecoustic Sculpt™ Ceiling tile is not suitable for back loading. Loads must be supported independently by the grid or through the use of additional fixtures.

## Tile Arrangements - 4' x 2'

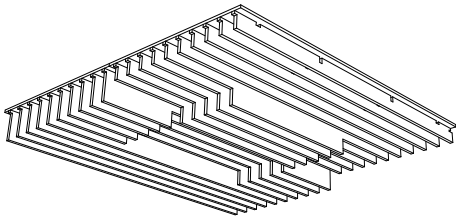

Add + Subtract Linear

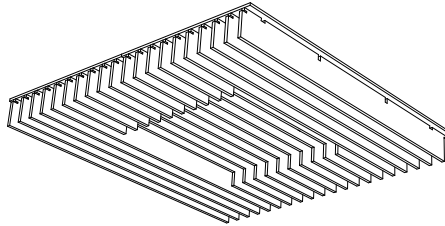

Add Linear

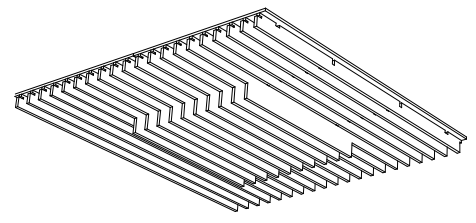

Subtract Linear

## ECOUSTIC SCULPT™ LIGHTING

To suspend lighting or sprinklers through the Sculpt™ System, the back scrim should be cut on top of the tiles. Once cut, services such as light fixtures, etc. can be secured to dedicated rails over the tile, which bridge between the suspended T grid ceiling to hang either within the Sculpt™ System or below the system. In regards to the linear tiles (Classic, Steps, Peak, etc.) a portion of the profile will need to be removed from the tile to leave openings for down lights. This would mean that light fittings should be in the center of the tile, with profiles on either side of the opening held via the systems combs and hanging rails.

**LED lighting is highly recommended for use with the Sculpt™ System**

