

# ECOUSTIC SCULPT™ FORT



unika vaev  

---

INSTYLE

Hear yourself think®

# ECOUSTIC SCULPT™ COLOR



ALMOND



ARIZONA



BLUEBELL

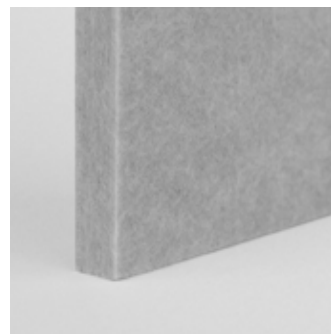

COOL



DENIM



FAWN



GALAXY



HORIZON



IRIS



LEAF



OLIVE

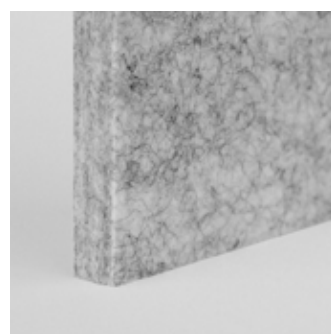

OXIDE



SNOWDROP



TUNGSTEN



VENUS

Product may vary in color due to the nature of the media  
Please refer to website for current color range

**ecoustic**® global leaders  
by INSTYLE in acoustic  
products

# ECOUSTIC SCULPT™ FORT

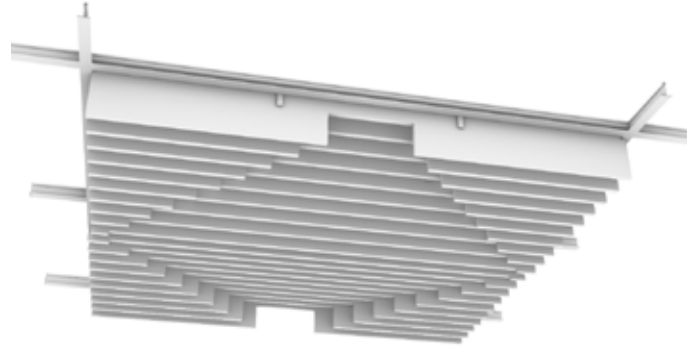

**CONTENT** 100% PET Panels with aluminum rails

**DIMENSIONS** 24 Tile- 23 13/16" x 23 13/16" x 4 1/2"  
(605mm x 605mm x 115mm)  
48 Tile- 47 13/16" x 23 13/16" x 4 1/2"  
(1215mm x 605mm x 115mm)  
Drops into existing T-Frame suspended ceiling systems with a nominal 24" x 24" or 48" x 24" grid.

**APPLICATION** Ceiling

**FIRE RATINGS** Class A  
ASTM E84  
AS/ISO 9705  
AS/NZS 1530.3

**VOC** Cal 01350 Complies

**ACOUSTIC** Base NRC: 0.65 - 0.75 (Applies to all profiles)  
With Infill NRC: 0.90 (Applies to all profiles)  
\*See graph on following page

**DROP CEILING** ecoustic Sculpt™ Ceiling tile is designed to be compatible with 9/16" (15mm) and 15/16" (24mm) exposed tee grid systems in slim and standard profiles. **Grid type must be specified with order.**

**DESCRIPTION** Sculpt™ Fort is a stepped and inclining profile similar to an architectural fortress. When installed as a collection - of two to eight tiles - the Fort profiles create diamond formations which begin to move in and out. The tiles are suited for a small and large ceiling installment.

## Designed for the Environment:

- Mindful MATERIALS
- Cal 01350 Compliant
- Low-VOC Certified
- Oeko-Tex Certified
- Prop 65 Compliant
- Declare CDHP Emissions Compliant
- HHI Compliant
- Global Greentag
- HPD
- ISO 14001-certified Environmental Management System
- Solid Core panels used to produce ecoustic® Baffle are Cradle to Cradle - Bronze certified

**Building Rating Systems:** Sculpt will contribute the following points for Green Star, LEED + WELL building standards.

Criteria	Green Star	LEED	WELL
Low VOC	√	√	√
3rd Party Certification	-	√	√
Toxic Material Reduction	N/A	N/A	√
Sound Reducing Surfaces	N/A	N/A	√



# ECOUSTIC SCULPT™ FORT

## 24 Tile

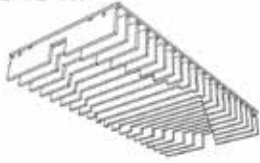

Both images are showing two tiles which are butted against each other to display the recessed pattern created

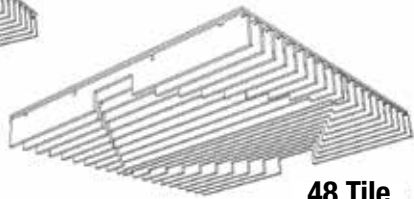

## 48 Tile

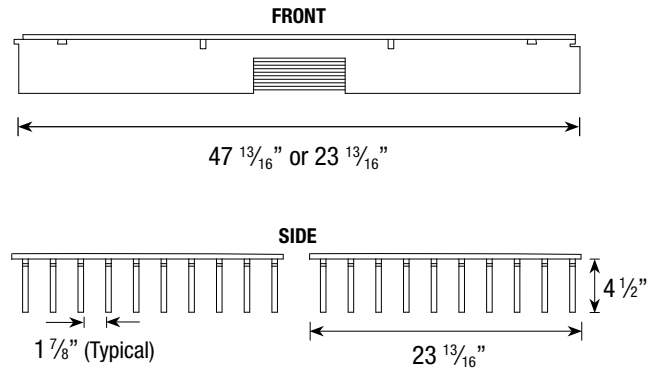

## ACOUSTIC RESULTS

ecoustic Sculpt™ consists of 15 profiles each with different surface areas. Acoustic testing was performed on the smallest (Network) and largest (Icon) profiles, with and without ecoustic® Infill. This gives ecoustic Sculpt™ a NRC range that covers all 15 profiles.

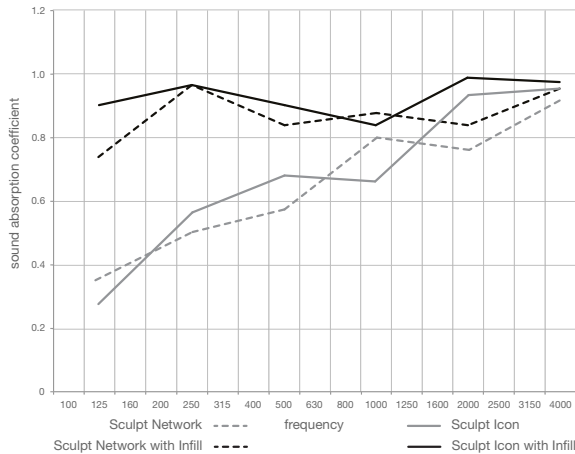

**Award-Winning + Patented Design:** The unique ecoustic Sculpt™ ceiling tile system has been awarded Australian Innovation Patent, New Zealand, United States & Patent Co-operation Treaty Patent Pending. ecoustic Sculpt™ has won four international awards:

- Neocon Best New Acoustic Panels and Solutions Gold Award 2018
- Good Design Australia Gold Award 2019
- Architizer A+Awards Finishes – Ceilings Winner 2019
- Interior Design Excellence Award Object Winner 2019

## IMPORTANT

**Toxicity:** Polyester is nontoxic and is classed the same as wood under the state of New York article 15 Part 1120. ecoustic Sculpt™ Ceiling tile does not contain any Red list chemicals (USA EPA), free of PFCs, flame retardants, phthalates, and urea formaldehyde.

**Moisture Absorption:** Exposure to an atmosphere of 50% and 95% RH for four days provides moisture absorption of less than 0.2% per volume. As ecoustic Sculpt™ is 100% polyester, it will not degrade over time due to moisture, mildew, or rot in office environments.

**Fixtures:** Any fixtures must be supported independent to the ecoustic Sculpt™ Ceiling tile. ecoustic Sculpt™ Ceiling tile can be cut on site to accommodate for new and existing lighting and fixtures.

**HVAC:** Ensure ecoustic Sculpt™ Ceiling tile is compliant with the specified HVAc system. ecoustic Sculpt™ Ceiling tile is recommended for Ducted Return Air and is not Plenum Return Air rated.

**Back Loading:** ecoustic Sculpt™ Ceiling tile is not suitable for back loading. Loads must be supported independently by the grid or through the use of additional fixtures.

**Versatile Ceiling Design Feature:** ecoustic Sculpt™ tiles can be assembled in varying orientations to create a large-scale ceiling design feature. The tiles can be installed in an identical linear formation, mirrored to create larger shapes across multiple tiles or in a random orientation. Additionally, alternate 2' x 2' tiles can be rotated 90° to create a checkerboard pattern. Multiple colors can be featured to create added depth and interest.

**Customizable:** Architects and interior designers can also create their own custom designs for an interior scheme with the ecoustic Sculpt™ system. Please refer to our ecoustic Sculpt™ Custom Design Guide.

## Tile Arrangements - 2' x 2'

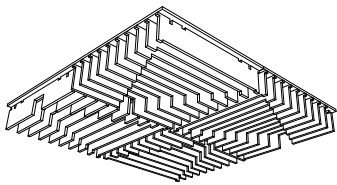

Checkerboard

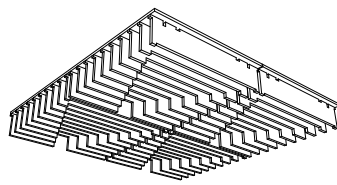

Linear

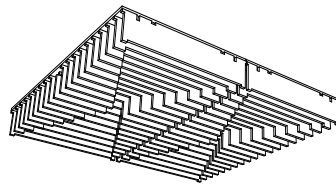

Mirrored Deep

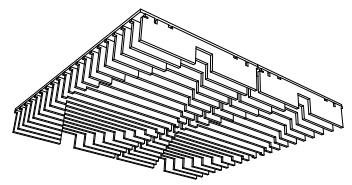

Mirrored Shallow

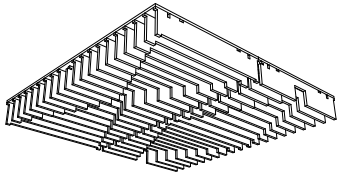

Mirrored Shallow + Deep

## Tile Arrangements - 4' x 2'

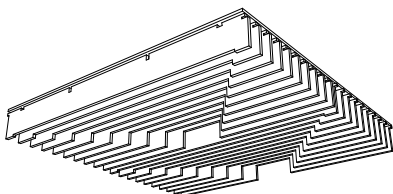

Linear

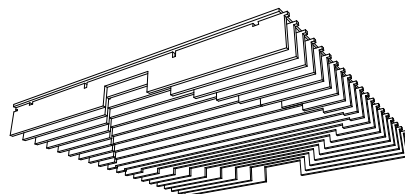

Mirrored Shallow

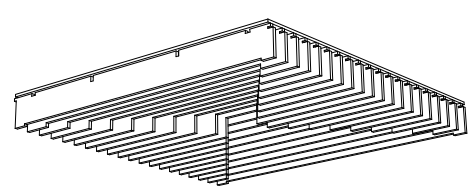

Mirrored Deep

### ASSEMBLY OPTIONS

- Fort profiles are located at equally spaced intervals. When installed as a collection of 2-8 tiles the Fort profiles result in diamond formations that move in and out, creating fluidity in movement.
- Suited to either a large or small space ceiling to capture the scale and form of the design.
- Installation pattern options may influence tile profile assembly. Written specification / Reflected Ceiling Plan reference to installation pattern is recommended.

Lighting: To suspend lighting or sprinklers through the Sculpt™ System, the back scrim should be cut on top of the tiles. Once cut, services such as light fixtures, etc. can be secured to dedicated rails over the tile, which bridge between the suspended T grid ceiling to hang either within the Sculpt™ System or below the system. In regards to the linear tiles (Classic, Steps, Peak, etc.) a portion of the profile will need to be removed from the tile to leave openings for down lights. This would mean that light fittings should be in the center of the tile, with profiles on either side of the opening held via the systems combs and hanging rails.

**LED lighting is highly recommended for use with the Sculpt™ System**

